

FT-727R OPERATING MANUAL



YAESU MUSEN CO., LTD.
C.P.O. BOX 1500
TOKYO, JAPAN

TABLE OF CONTENTS

§1.0	SPECIFICATIONS	2
§1.1	General	2
§1.2	Receiver	2
§1.3	Transmitter	2
§1.4	Supplied Accessories	4
§1.5	Options	4
§2.0	CONTROLS, SWITCHES & CONNECTORS	6
§2.1	Top Panel	6
§2.2	Front Panel	9
§2.3	Sides and Rear Panel	12
§2.4	Battery Track	13
§3.0	ACCESORIES	14
§3.1	Battery Packs	14
§3.2	Battery Removal and Replacement	15
§3.3	Battery Chargers	16
§3.4	YH-2 Headset, VOX Operation & MH-12 _{A2B} Speaker/Mic	18
§3.5	Antenna Considerations	19
§3.6	Memory Backup Information	19
§3.7	FTS-6 Tone Squelch Unit Installation	20
§4.0	OPERATION	22
§4.1	Preliminary Operating Information	22
§4.2	Squelch Setup	23
§4.3	Transmitting Procedure	23
§4.4	Band Selection	24
§4.5	Frequency Selection	25
§4.6	Storage & Recall of Frequencies in Memory	26
§4.7	Call Channel Storage & Recall	27
§4.8	Repeater Operation	27
§4.9	Step Selection and Band Scanning	28
§4.10	Memory Scanning	29
§4.11	Priority Channel Monitoring	30
§4.12	Power Saver	30
§4.13	Programmable Memory Scanning (PMS)	32
§4.14	Split Transmit/Receive Memories	33
§4.15	Tone Squelch Operation (version A w/ FTS-6 option)	33
§4.16	Crossband Semi Duplex Operation	34
§4.17	Miscellaneous: Beep, Lock and Battery Voltage	35
§4.18	In Case of Problems	35
§4.19	Getting the Most From Your Batteries	37

YAESU FT-727R

DUAL BAND FM HANDIE TRANSCEIVER

The FT-727R is a VHF and UHF FM hand portable transceiver providing up to 5W or 0.5W RF output on user-selectable channel steps across both the 2m and 70cm (FM) amateur bands. Twenty dual-function keys on the front panel provide 40 different commands for programming the CMOS microprocessor at the heart of the FT-727R. Ten standard memories are provided, four of which allow storage of independent transmit and receive frequencies, for odd repeater splits or cross band operation, with touch-key reverse. Independent 'dial' and call memories are provided for each band, and repeater shift may be selected and programmed as desired while operating on any memory or dial frequency.

The manual or auto-stop/resume scanning capabilities include step-programmable full or partial band or memory bank scanning; calling channel, select memory or dial priority scanning/monitoring, and other unique yet useful functions too numerous to list, but all programmable from the front panel keypad or remotely via the CAT* external computer jack.

Operational battery charge life can be greatly extended over standard squelched reception when monitoring, with Yaesu's programmable Power Saver System, which only activates the receiver to check the selected channel momentarily at programmable intervals.

The liquid crystal display includes a 10-step bargraph meter showing received signal strength or relative output power. Revolutionary features include a digital voltmeter to display actual battery voltage, a latching lamp switch to illuminate both the display and each keypad button, and of course the miniCAT System, allowing entry of all keypad functions from an external computer.

* CAT = Computer-Aided Tuning.

1.0 SPECIFICATIONS

1.1 General

Frequency range:	per local requirements (see Model Chart)
Channel steps:	" " " " " " "
Mode:	F3 (F3E)
Antenna:	BNC female (special dual-band YHA-27 rubber duck supplied)
Supply voltage:	6-15 VDC
Current:	see Chart 1
Case Size:	71(W) x 200.5(H) x 38(D) mm w/FNB-4A
Weight:	Approx. 557g w/FNB-3A, 616g w/FNB-4A

1.2 Receiver (@10.8V)

Circuit type:	Double conversion superheterodyne
First IF:	16.9 MHz
Second IF:	455 kHz
Sensitivity:	0.25uV for 12dB SINAD; 1uV for 30dB S+N/N
Selectivity:	± 7.5 kHz (-6dB), ± 15 kHz (-60dB)
Audio Output:	450 mW into 8 ohms for 10% THD, or better

1.3 Transmitter (@10.8V)

RF input/output:	see Chart 2
Modulation:	Variable reactance
Deviation:	± 5 kHz
Maximum bandwidth:	16 kHz
Spurious response:	-60 dB or better
Microphone:	condenser, 2 kilohms

Specifications subject to change without notice.

MODEL CHART

MODEL:	A	B	B1
Freq. range (VHF) (MHz) (UHF)	144 - 148 440 - 450	144 - 146 430 - 440	144 - 146 430 - 440
Ch. steps (VHF) (kHz) (UHF)	5/10 12.5/25	12.5/25 12.5/25	12.5/25 12.5/25
Std. Rptr (VHF) Shift (MHz) (UHF)	0.6 5	0.6 1.6	0.6 7.6

1750 Hz Burst Generator standard in versions B & B1
 FTS-6 Tone Squelch Encoder/Decoder optional for Model A

CHART 1: Supply Current (mA)

<===== with 10.8V supply =====>					12.5V supply	
Receive	Squelched	Power Save (1:2 - 1:18)	Transmit		Transmit	
			(High)	(Low)	(High)	(Low)
(VHF) 150	50	24 - 14	1300	550	1300	550
(UHF) 150	50	24 - 14	1350	600	1400	600

CHART 2: RF Power

(Watts, w/50-ohm resistive load)

	VHF		UHF	
	Input	Output	Input	Output
FBA-5A*	3.5	2.0	3.5	2.0
FNB-3A	9.5	4.5	9.8	4.5
FNB-4A	12	5	14	5

* FBA-5A holds AA-size dry cells (6)

1.4 SUPPLIED ACCESSORIES

YHA-27	VHF/UHF Rubber Flex Antenna
DTMF Encoder	(Built in)
1750Hz Burst Generator	(except version A)

Note: certain options may be included as standard accessories according to local needs or popularity.

1.5 OPTIONS

FNB-3A*	425 mAh Ni-Cd Pack
FNB-4A*	500 mAh Ni-Cd Pack
FBA-5A*	Dry Cell battery case (for 6 AA cells)
CSC-17	Soft Case (for FT-727R w/FNB-3A or FBA-5A)
CSC-18	Soft Case (for FT-727R w/FNB-4A)
FTS-6	Tone Squelch Unit (Model A only)
YH-2	Headset (for VOX operation)
MH-12A2B	Speaker/Microphone
NC-9B/C	117/220 VAC Compact Charger (for FNB-3A)
NC-18B/C	117/220 VAC Compact Charger (for FNB-4A)
NC-15	Quick Charger/DC Supply
PA-3	DC Car Adapter/Trickle Charger
MMB-21	Mobile Hanger Bracket

* The "A" suffix on these battery packs denotes case color only. Battery packs with the same numbers without the "A" suffix may also be used.

Except for antennas, accessories for the FT-203, FT-703, FT-209 and FT-709 models may also be used with the FT-727R.



FBA-5A



FNB-3A



FNB-4A

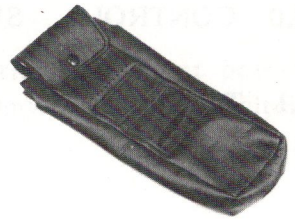

CSC-17,18



YH-2



MH-12A2B



MMB-21

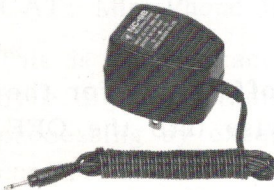

NC-9B

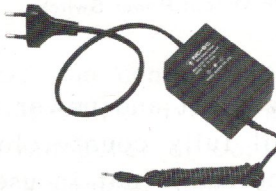

NC-9C

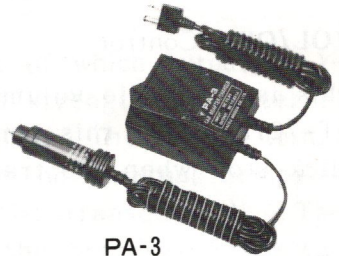

PA-3



NC-18B

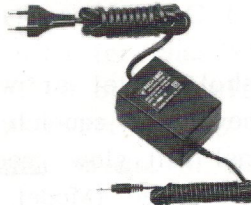

NC-18C

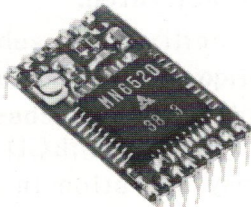

FTS-6



FT-727R/NC-15

2.0 CONTROLS, SWITCHES & CONNECTORS

2.1 Top Panel

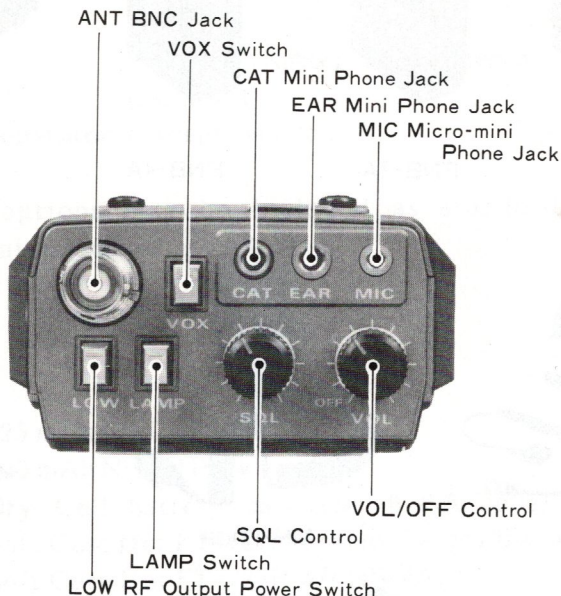

VOL/OFF Control

This is the audio volume control and power on/off switch for the FT-727R. Set this control fully counterclockwise into the OFF click-stop when the transceiver is not in use.

SQL Control

This control sets the threshold level at which received signals will open the squelch. Whenever the squelch is open the ON AIR-/BUSY LED on the front panel will glow green. When the optional FTS-6 Tone Squelch Unit is installed (Model A only) and activated as a decoder, this control sets the threshold at which the LED will light and the scanner stop, if activated.

LAMP Switch

When this switch is depressed, the front panel LCD display and the keypad keys are illuminated, for easy operation in the dark.

MIC Micro-mini Phone Jack

This jack accepts transmitter audio input from the optional MH-12A2B Speaker Microphone or the YH-2 Headset. When this jack is used the internal microphone in the front panel is disabled.

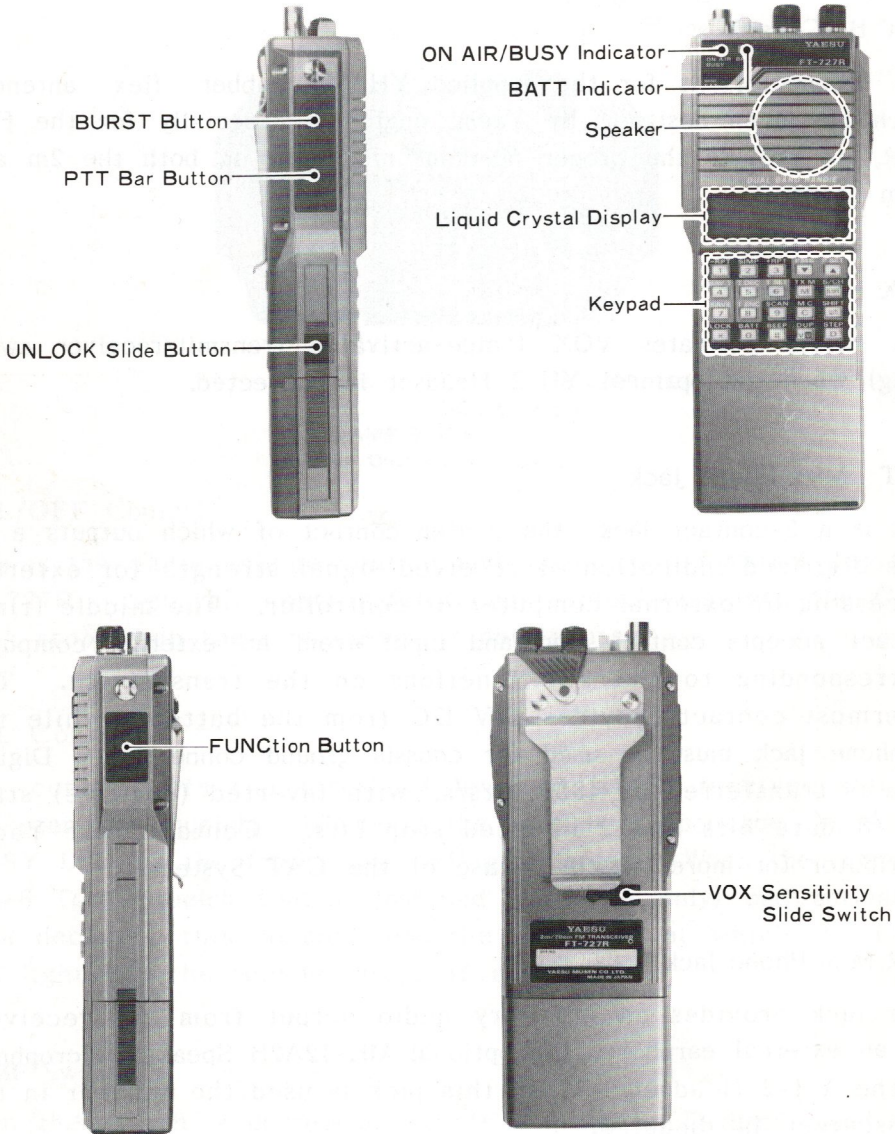

2.2 Front Panel

Speaker

Behind the grill at the top of the front panel is a 36mm diameter speaker.

Liquid Crystal Display

This display shows the operating frequency (Version A: 6 digits; Versions B & B1: 6½ digits) or battery voltage (2½ digits) as well as the status of 13 special functions that may be activated. The numbered bargraph along the bottom of the display shows either relative received signal strength, relative transmit power output or the status of the 10 memories.

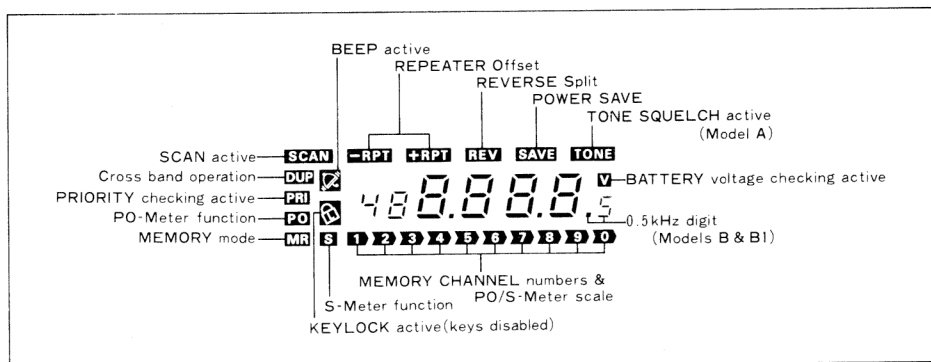

Keypad

The twenty keys on the keypad are used for selecting the frequency and various special functions of the FT-727R during reception. The number, letter or symbol on the face of each key indicates the primary function of the key, while the label on the panel just above each key indicates the alternate function, activated by holding the FUNCTION button on the left side of the transceiver. During transmission, only the leftmost sixteen keys are active (as DTMF encoder) during transmission.

Following is a description of the primary function of each key (during reception). The special "shifted" functions are described later in the Operation section.

Numbered keys

The keys numbered **1** through **9** and **0** are used for numerical data entry of frequencies, memory channel numbers and certain other special functions.

[▲] Scan Up or [▼] Down

These keys step the operating frequency up or down one step, or one memory channel. Press and hold the key in for more than one second to engage the scanner.

[M] Memorize

Press this key followed by a memory channel number to memorize the dial frequency.

[MR] Memory Recall

Press this key to activate the memory mode on the last selected memory channel.

[D] Dial Mode

When in the dial mode, after keying in a frequency on the keypad, press this key to actually enter the displayed data and change to the new operating frequency. If this key is pressed while receiving on a memory, operation will shift to the last frequency used in the dial mode.

[C] Clear

If you accidentally press the wrong button when entering a frequency or other data, press this button to clear the entry.

[⇐] Reverse

During split frequency operation, such as through a repeater, this key allows instant exchanging of the transmit and receive frequencies ("reverse split"), so you can check signals on the repeater input, and transmit directly 'around' the repeater. 'REV' appears at the top center of the display when this function is active.

[*] Call CH Recall

This key instantly recalls one of two memorized call channels.

[#] Priority Monitor

Press this key to activate the priority channel monitor function, described in the 'Operation' section.

[VU] VHF/UHF Band Selector

Press this button in the dial mode to select the alternate band (2m or 70cm).

ON AIR/BUSY Indicator

This dual-color LED glows green whenever the squelch is open during reception. This is normally due to the presence of a signal on the channel, but can be caused by noise if the SQL control is set too far counterclockwise.

The same indicator glows red when transmitting.

BATT Indicator

This LED glows red when the battery voltage drops to about 6.5V, indicating that the battery should be recharged or replaced immediately. You can check actual battery voltage as described later.

2.3 Sides and Rear Panel

PTT Bar Button (left side)

Press the soft rubber PTT switch on the left side of the transceiver to transmit, and release it to receive. The red ON AIR lamp should be lit while this switch is depressed.

BURST Button (left side: European versions only)

Press this button simultaneously with the PTT button to manually transmit a 1750 Hz burst tone to access repeaters that require it. The tone will be transmitted for as long as this button (and PTT) are held.

UNLOCK Slide Button (left side)

To remove the battery pack, hold this button upwards to release the safety catch and allow the battery to be slid (to the left) out of its mounting track.

FUNCTION Button (right side)

Press (and hold) this rubber button on the right side of the transceiver to activate the alternate functions of the keypad buttons, labelled just above each button on the front panel.

VOX Sensitivity Slide Switch (rear panel, under rubber cover)

When the FT-727R is used with the optional YH-2 Headset and the VOX switch on the top panel is depressed, this switch selects high/low sensitivity of the VOX circuit to microphone audio. In a noisy environment this switch should be set to the LOW position to suppress false triggering of the transmitter by ambient noise.

2.4 Battery Track

RAM Backup Slide Switch

The Backup switch turns the lithium memory backup circuit on and off. This switch is set to be on at the factory, and normally should not be turned off, except for a few seconds when resetting the microprocessor as described in §4.18, or when the transceiver is to be stored for an extended period.

Clone Slide Switch

The Clone slide switch is used at the factory during production, to store default settings in the Dial mode and to clear the memories after testing and alignment. When the transceiver leaves the factory, this switch is set to the receiving position, and it should be left that way. The other position is used only to read RAM data rapidly during production.

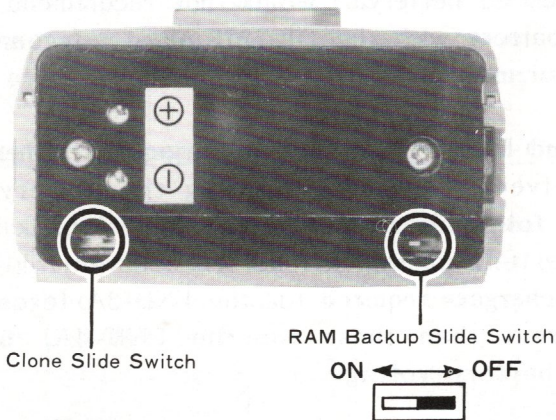

3.0 ACCESSORIES

3.1 Battery Packs

The following battery packs are recommended for use with the FT-727R:

FNB-3A 10.8V 425mAh Ni-Cd Battery Pack

FNB-4A 12V 500mAh Ni-Cd Battery Pack

Also available is the **FBA-5A** Battery Case for 6 AA-size dry cells (non-rechargeable, batteries optional).

The FNB-3, FNB-4 battery packs and FBA-5 battery case (without "A" suffix) may also be used with the FT-727R, although side color does not match.

In some countries, one or more of the above may be supplied with the transceiver. If not, contact the nearest Yaesu dealer to purchase the desired battery. We do not recommend the use of any other type of battery with the FT-727R, and using another type may affect your warranty.

The FNB-3A and FNB-4A are both rechargeable, either while attached to the transceiver or separately, using the battery chargers described on the following pages. Each Ni-Cd pack should be fully charged before it is used with the transceiver for the first time. Note that the chargers required for the FNB-3A (except for the NC-15) are different than those for the FNB-4A, because of the difference in battery voltage.

RF power output from the transmitter will differ in some cases according to which type of battery is used, with the FNB-4A providing the highest output and the FBA-5A with fresh dry cells providing about half of that.

3.2 Battery Removal and Replacement

1. Make sure that the VOL control is set into the OFF click-stop, and remove the protective soft or hard case, if used.
2. Grasp the upper portion of the transceiver with your left hand, so that your palm is over the speaker and your left thumb is on the UNLOCK button.
3. Move the UNLOCK button in the direction indicated by the small arrowhead, while using your right hand to slide the battery case toward the side with the UNLOCK button. The battery case should slide smoothly out of its track.
4. If using the FBA-5A battery case and dry cells, they can be removed from the case by placing both of your thumbs on the mounting tracks on top of the case and gently prying the tracks apart. Although both sides must be opened to change the cells, only one side must be opened at a time, to avoid damage to the hinges. First install or replace the three cells in one side, and then close that side, open the other side, and install or replace the other three cells. Always replace all six cells.

Do not attempt to open the FNB-3A or -4A Ni-Cd packs.

5. To replace the battery case or Ni-Cd pack, repeat steps 2 and 3 above, simply sliding the battery case in the other direction after aligning the shorter side of the battery case with the track below the UNLOCK button.



3.3 Battery Chargers

NC-9B/C

The NC-9B (117VAC) and NC-9C (220–234VAC) are compact chargers for recharging the FNB-3A Ni-Cd battery pack from the AC line. A completely discharged pack requires approximately 15 hours to recharge with the NC-9B/C. Do not attempt to charge the FNB-4A with the NC-9B/C, as the charging voltage is not high enough.

NC-18B/C

The NC-18B (117VAC) and NC-18C (220–234VAC) are compact chargers for recharging the FNB-4A Ni-Cd battery pack from the AC line. A completely discharged pack requires approximately 15 hours to recharge with the NC-18B/C. Do not attempt to charge the FNB-3A with the NC-18B/C, as the charging voltage is too high.

It is not necessary to remove the battery pack from the transceiver when charging, but the transceiver can not be operated while the NC-9B/C or NC-18B/C is connected. Therefore it is advisable to have an extra battery pack on hand so that the transceiver can be used while the spare pack is being charged.

Do not attempt to recharge dry batteries used in the FBA-5A.

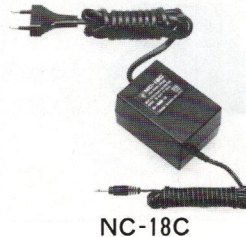
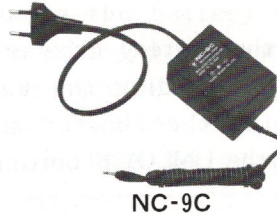
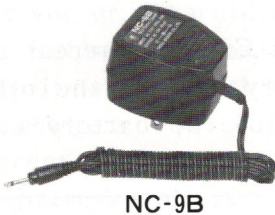

NC-15 Quick Charger/Power Adapter

The NC-15 is a battery charger/DC supply with quick and trickle charging modes. The quick mode is automatically selected initially, to bring the battery pack up to full charge as fast as safely possible. The charger then automatically reverts to the trickle mode, to prevent self-discharge. The quick mode recharges a completely discharged FNB-3A in about 1 hour, or FNB-4A in about 1.5 hours. The DC power supply function allows the transceiver to be operated while also charging an attached battery pack.

PA-3 Mobile DC-DC Adapter

The PA-3 is a DC-DC adapter for use when operating the transceiver mobile. The PA-3 provides a constant trickle charge to the FNB-3A or -4A, which helps to preserve charge life while operating the transceiver. Use with 12-volt negative ground electrical systems only.

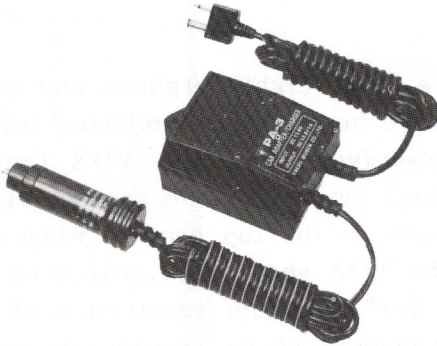

PA-3



FT-727R/NC-15

3.4 YH-2 Headset, VOX Operation & MH-12_{A2B} Speaker/Mic

Either of these optional accessories can be used to increase operating convenience and extend communications range and signal strength. Each is equipped with a dual plug connector which mates with the EAR and MIC jacks on the top panel of the transceiver, disabling the internal speaker and microphone. The connecting cable then allows the transceiver to be left clipped to the operator's belt, or to be held overhead above obstructions for improved performance, if required. For mobile operation with the MMB-21 Mobile Hanger, the transceiver can be left in the Hanger during transmission.

The **MH-12A2B** Speaker/Microphone can be held close to the ear during reception; or if preferred, an external earphone can be connected to the transceiver via the speaker/mic plug, attenuating the audio from the speaker in the MH-12A2B. To transmit, just hold the speaker/mic close to your mouth and close the PTT switch on the microphone.

The **YH-2** Headset includes both a lightweight earphone and miniature boom microphone with a single headband, permitting totally hands-free operation of the transceiver when the VOX (voice-actuated transmit/receive switching) system in the transceiver is activated by pressing the VOX switch on the top panel. When in a normal, quiet environment, set the VOX sensitivity switch on the rear panel to the high position, for maximum sensitivity of the VOX circuit. If in a noisy environment where extraneous sounds might trigger the VOX inadvertently, set the VOX sensitivity switch to the low position.

To transmit when using the YH-2 it is only necessary to speak. The boom microphone will pick up your voice, which will automatically activate the transmitter and be sent out over the air (watch what you say). To return to receive, just stop talking.

3.5 Antenna Considerations

While the supplied YHA-27 rubber flex antenna provides great convenience for short-range portable operation, the standard BNC-type antenna connector on the transceiver allows for the use of higher gain antennas for extended range in base or mobile operation. However, any antenna connected to the transceiver must have an impedance close to 50 ohms on all operating frequencies. This means that any antenna used in place of the YHA-27 must be a dual band type specifically designed for both 2m and 70cm operation, or operation must be restricted to one band.

Also, if the antenna is to be connected with a feedline to the transceiver, high quality 50-ohm coaxial cable should be used.

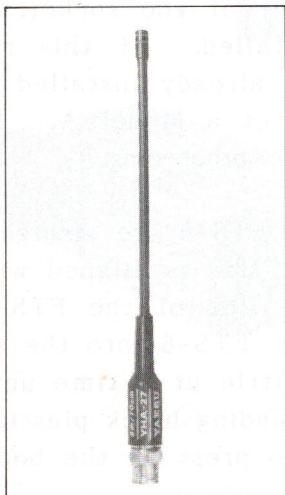

3.6 Memory Backup Information

Operating data programmed in the FT-727R is retained in memory by an internal lithium cell even when the power is off and the battery removed. This backup cell has an estimated lifetime of five years, after which time data may be lost when power is switched off. When that occurs, see your Yaesu dealer for installation of a replacement backup cell.

3.7 FTS-6 Tone Squelch Unit Installation

The FTS-6 can be installed in Model A versions of the FT-727R, and is available from Yaesu dealers in those countries where the Model A versions are sold.

1. Make sure the transceiver is off. Remove the hard or soft case, if used, and remove the battery pack as described previously.
2. Remove the two screws affixing the battery mounting track on the bottom of the transceiver, and carefully remove the track.
3. Locate the 1/8-watt, 27-kilohm resistor that is inserted in one side of the (otherwise empty) socket on the bottom of the transceiver, and pull the resistor out of the socket. It is not needed when the FTS-6 is installed. If this resistor cannot be found, or if a circuit is already installed in the socket, the transceiver is probably not a Model A. In this case, contact your Yaesu dealer before proceeding.
4. Make sure that all of the pins on the FTS-6 are straight, and position the FTS-6 so that the 8-pin side is aligned with the 8-pin side of the socket (the other side of the FTS-6 and socket has 7 pins). Gently press the FTS-6 into the socket, rocking the board back-and-forth a little at a time until the top of the IC is flush with the surrounding black plastic inner cover. Do not use a sharp object to press on the board, as this may damage the circuitry.
5. Replace the battery mounting track and its two screws, followed by the battery pack, which should fit as smoothly as before if the FTS-6 is properly seated.

See the "Operation" section for details of tone squelch operation.

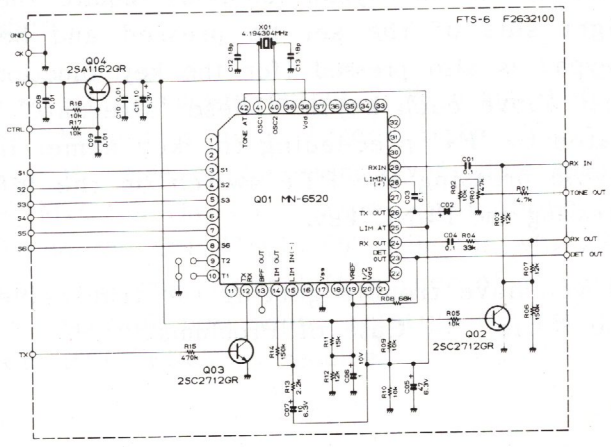
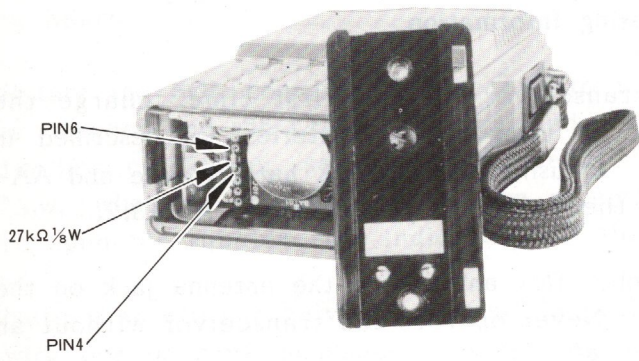
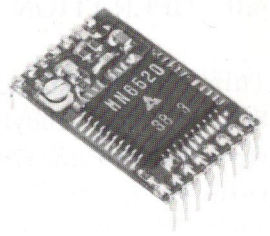
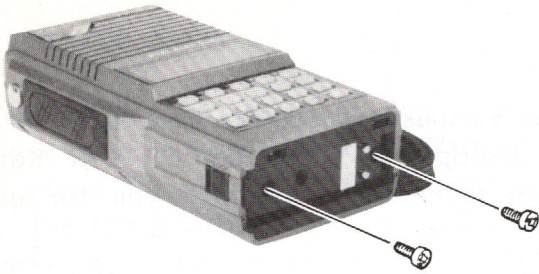

4.0 OPERATION

This chapter describes the various transceiver functions in detail. After studying these descriptions, keep the 'FT-727R Keypad Operating Functions' handie reference card with you for quick reference.

4.1 Preliminary Operating Information

Before operating the transceiver for the first time, charge the battery pack completely (if using Ni-Cd batteries) as described in the preceding section. If using the FBA-5A battery case and AA-size batteries, install the batteries as described in §3.2.

Connect the YHA-27 rubber flex antenna to the antenna jack on the top of the transceiver. Never operate the transceiver without an antenna connected.

VOX operation using the YH-2 Headset is described in §3.4. For now, do not connect the YH-2 or the MH-12_{A2B} Speaker/Mic. Set the VOX button on the top panel to the undepressed position (until you are familiar with basic operation).

Note:

Half of the 40 keypad functions require that the FUNC key on the right side of the set be pressed and held while a key on the keypad is also pressed (for the key functions marked on the keypad just above each key). These 'alternate' key functions are indicated by 'F+' preceding the key names in the following sections. Avoid pressing the PTT switch on the left side of the set when pressing the FUNC key.

If you have trouble getting the transceiver to work as described, see §4.18, 'In Case of Problems'.

4.2 Squelch Setup

Before turning on the transceiver, set the SQL control fully counterclockwise. Now rotate the VOL control out of the click-stop and adjust for a comfortable volume on the noise or received signal. The ON AIR/BUSY indicator LED should glow green. If a signal is present, press either the up or down arrow key at the upper right of the keypad, until a frequency is found where only noise is heard.

Rotate the SQL control clockwise just to the point where the noise is silenced and the LED is extinguished. If the SQL control is set further clockwise, sensitivity to weak signals will be reduced. Now, whenever a signal reaches the receiver that is strong enough to open the squelch, the indicator will glow green.

Note that while receiving, a small 'S' will be displayed together with one or more numbered bargraph segments along the bottom of the display, indicating signal strength on the receiving frequency. This indication is not affected by the squelch setting, so even squelched signals will have some indication. If you notice more than one or two bargraph segments appearing while the squelch is still closed, try reducing the squelch control setting (if you want to hear weak signals).

4.3 Transmitting Procedure

Press the LOW button to select low power output. When you wish to transmit, wait until the channel is clear (green LED off), and squeeze the PTT switch on the side of the transceiver while speaking into the microphone (MIC on the front panel, just above the display). During transmission the ON AIR/BUSY indicator will glow red, and 'PO' will appear near the lower left corner of the display, indicating that the bargraph now shows relative transmitter power output. Release the PTT switch to receive.

If more power is required, set the LOW button to the undepressed position. However, whenever communication is possible with low power, keep to LOW button depressed to conserve battery life and minimize possible interference to other stations.

When operating in a dark environment, the LAMP button can be pressed to illuminate the display and keypad.

Be careful: pressing the keypad keys (except those in the right-most column) while transmitting will cause a DTMF tone to be transmitted (and the keypad to beep).

Note: If the BATT indicator LED (to the right of the ON AIR/BUSY indicator) starts to glow red, the battery pack should be recharged or batteries replaced (in the FBA-5A).

4.4 Band Selection

Press the **V/U** key to select the VHF or UHF band*. On VHF, the frequency display will begin with a half-size '14', meaning 140 MHz. On UHF, '43' (for 430 MHz) or '44' (for 440 MHz) will appear. These digits are fixed by band selection according to the version of FT-727R you have. Changing bands with the **V/U** key always selects the 'Dial mode', which is a special mode that allows tuning and scanning by channel steps throughout the band (like a vfo). Frequencies set in the Dial mode on one band are retained in memory when operating on the other band.

* if nothing happened, see if there is a padlock icon showing on the display. If so, press **F+LOCK** to unlock the keys.

4.5 Frequency Selection

On a selected band, there are two ways to select your operating frequency: by tuning with the up/down arrow keys, or by directly keying in frequency digits. The transceiver must be in the Dial mode, which can be selected at any time (without changing bands) by pressing the **D** key.

To key in a different frequency:

- (1) Press **D** (only required if not in Dial mode already).
- (2) Press one to four digits, for 1's of MHz, and 100's, 10's and 1's of kHz. Press **C** to clear if you make a mistake.
- (3) Press **D** to enter the new frequency.

If less than four digits are entered in step (2), the digits to the right will be filled by zeros at step (3). If the entered digits are for a frequency that is out of band (for your version of FT-727R), the new data will be ignored at step (3), and you will return to the original frequency. Also, if you enter digits for a frequency that is not on a channel step for your version, the next lower valid channel will be selected at step (3).

In versions with 12.5 kHz steps, a small '.5' is appended at the right side of the frequency digits on appropriate channels. This does not need to be keyed in (enter a '3' or an '8' for the 1's of kHz digit, and the next lower step will be selected).

EXAMPLE: to enter 145.550 MHz

Press **D**, and then 555, and **D** again.

4.6 Storage & Recall of Frequencies in Memory

To store a frequency in memory, first enter the desired frequency in the Dial mode as described above. Then press **M** (memorize), followed by a memory channel number, from 0 to 9.

After pressing **M**, a little 'MR' will appear at the lower left corner of the display, which will disappear when the memory number key is pressed. Remember that when you store data in memory, the data previously stored in that channel (if any) is erased.

EXAMPLE: to store 145.00 MHz in channel 0

Press **D** to select the Dial mode, and press **5** and then **D**, followed by **M** and then **0**. Notice that only one frequency digit had to be entered, since the others are zeroed automatically.

To recall a memory press the **MR** key followed by the channel number, from 0 to 9. The small 'MR' will be displayed at the lower left, along with the recalled channel number as one of the bargraph segments. If the channel had had data stored in it, the frequency will appear on the display. Otherwise, on an empty memory, only a decimal point will appear in place of frequency.

Once a memory has been recalled, the transceiver will be in the 'Memory mode' (as opposed to the Dial mode described before). In the Memory mode, pressing the up/down arrow keys and keypad digits selects memory channels, instead of usual channel steps. Note that the up/down arrow keys select only occupied memories. Also, the bargraph indicates the selected memory number, until the PTT button is pressed, at which time the bargraph returns to display PO (power output) and signal strength. This can also be toggled back and forth by pressing **F+S/CH**.

To exit the Memories and return to Dial mode, press **D** (or **V/U**).

4.7 Call Channel Storage & Recall

The "Call" channel is a special memory that can be instantly recalled with a single press of the * key from most operating modes. The frequency display of the Call channel is distinguished by a small 'c' in place of the 1 kHz digit on the right side of the display. This is the place to store your primary operating frequency (the one you need most often), or an emergency calling frequency that may have to be recalled quickly.

Storing the Call frequency is identical to standard memory storage just described: set the Dial to the desired frequency (§4.5), and press **M** followed by the * key.

To recall the Call channel when receiving in the Dial or Memory modes, just press *.

There are actually two Call channels: one for VHF and another for UHF. Which one is recalled is determined by the band selected for the Dial mode at the time the * key is pressed.

4.8 Repeater Operation

Standard (default) repeater shift is +/-600 kHz on VHF, and +/-5, +/-1.6 or +/-7.6 MHz on UHF, according to version. Check the shift of your version by pressing **F+SHIFT**. The display will show the shift for the band that you are operating on (in two digit decimal MHz). If you wish to change the shift frequency offset, key in two digits on the keypad (1's of MHz and 100's of kHz), and then press **D** to return to the Dial frequency, but with the new shift stored for recall later by the +/- RPT keys.

To set the operating frequency for repeater shift, press **F+ -RPT** or **F+ +RPT**, according to the direction you wish to have the transmitter shift from the receiving frequency. A small '+RPT' or '-RPT' label will appear above the operating frequency, and when the PTT switch is pressed, the operating frequency will shift in the

selected direction (if it is within the band) by the amount determined by the shift setting (in the preceding paragraph, above). If the shifted frequency is outside of the amateur band, 'Err' is displayed when the PTT switch is pressed, and no transmission occurs. In this case, check your shift direction and amount.

You can also check the frequency to be used for transmission by pressing the left/right arrow key (right side, 3rd row). 'REV' will appear at the center of the display above the frequency, indicating that the transmit and receive frequencies used in semi-duplex operation are REVERSED, so you can easily see if your repeater frequencies are correct, and also check the repeater input frequency to see if you can work a particular station direct. Press the left/right arrow key again to return to the original repeater shift.

You can store repeater shifts in memory just by setting up the Dial for repeater operation as above, and then storing it as described in §4.6.

To cancel repeater shift, press **F+SIMP**.

See also §4.14, 'Split Transmit/Receive Memories'.

4.9 Step Selection and Band Scanning

All scanning can be manually activated and deactivated by the up/down arrow keys. If the transceiver is in the Dial mode then at the first press of these keys the frequency will step up or down from the initial frequency by one channel step. Channel step sizes are 12.5 or 25 kHz on UHF, and either 5 or 10 kHz, or 12.5 or 25 kHz on VHF (depending on version and STEP selection). Press **F+STEP** to toggle between the two step sizes available in your version for the selected band.

To manually scan the band, press and hold the up or down arrow key for more than half a second, and release the key to halt.

For automatic scanning, first make sure the squelch is set properly (§4.2), and then press **F+SCAN**. 'SCAN' will appear at the upper left corner of the display, and when the up or down arrow key is held for half a second, automatic scanning will start (and you can release the key). In this state, scanning will pause when a signal is received that is strong enough to open the squelch, and resume a few seconds after the squelch closes (signal drops out). You can force the scanner to halt at any time by pressing the PTT switch, or **C** or **D**. If you use the PTT switch to stop the scanner, release it and press it again to transmit.

4.10 Memory Scanning

If the transceiver is set to the Memory mode ('MR' displayed in the lower left corner), the up or down arrow keys cause selection of the next higher or lower numbered occupied memory channel. Only those channels which actually have frequencies memorized will be selected. Holding the up or down arrow key for more than a half second will cause manual scanning through the memories.

When the Memory mode is selected and the automatic SCAN function is activated as described in the preceding section, the occupied memories will be scanned automatically, pausing on signals on the memorized frequencies. Press the PTT switch to stop, and then release it and press it again to transmit.

Note: Since only occupied memories are scanned, you may wish to delete some memories which you do not want included in scanning. Press **F+MC** followed by the memory channel number to clear a memory. All data stored in the memory will be erased.

4.11 Priority Channel Monitoring

The Priority function allows periodic checking of a memory channel while operating on the Dial frequency or Call channel. When a signal appears on the memory while receiving, operation will automatically shift to that memory.

The squelch must first be preset (§4.2), and the frequency to be monitored must be stored in a memory channel (§4.6). Also, the frequency you will be operating on must be selected in the Dial mode or Call channel.

Press the # key followed by the memory number to activate Priority monitoring. 'PRI' will appear at the left side of the display, and every few seconds (while receiving), the selected memory will be checked (the displayed frequency will shift to the memory, and 'MR' and the channel number will appear).

When a signal appears on the memory, operation will jump to that frequency, and 'PRI' will disappear. If this interrupts a QSO, press **D** to return to the Dial frequency (or the * key to return to the Call channel), and then **MR** to return to the priority channel.

Priority operation can be terminated manually at any time by pressing **D** or *, to return to the Dial or Call channel.

4.12 Power Saver

This feature is provided to minimize current drain from the battery while waiting for a call. When the Save function is active, the receiver will "sleep" for a preset length of time (the "Save Time"; from 1 to 9 seconds) between half-second checks for activity on the preselected frequency. When a signal is found during one of the checks, the Save function will automatically pause to receive the signal until the carrier disappears.

Before activating the Save function, the squelch must first be preset (§4.2), and the desired operating frequency selected for operation (Dial, Memory or Call channel). The default Save Time setting is 9 seconds, which you can reset as described in the next section (§4.12.1).

To activate the Save function, press **F+SAVE**. 'SAVE' will be displayed near the upper right, and the transceiver will immediately go to "sleep". In this state, the display shows the remaining sleep time in 2-digit decimal seconds, counting down to 0.0, at which point the operating frequency is briefly displayed while the channel is checked. If the squelch does not open (no signal present), the timer will reset to the Save Time and start again. Very little current is drawn while the countdown timer is displayed, as all other transceiver functions are switched off by the microprocessor.

The activation status of the Save function is stored in backed-up RAM, so even if the transceiver is switched off and the battery pack removed, the same status will remain when the set is again switched on. To manually deactivate the Save function, press **F+SAVE** while 'SAVE' is displayed.

4.12.1 Power Save Time Setting

The "sleep" duration between channel checks in the SAVE function may be preset. Default is 9 seconds (the maximum available). Long settings provide maximum power savings, but are also more likely to miss short calls on the checked frequency. However, if you can be assured that the calling station(s) will make calls at least 10 seconds long, use the 9-second Save Time setting for maximum battery life.

Press **F+SAV T** to check the current Save Time setting. If you wish to reset the Save Time, press the numbered key corresponding to the desired number of seconds, from 1 to 9. Press **F+SAV T** again to return to normal display.

4.13 Programmable Memory Scanning (PMS)

The PMS function provides limited band scanning for a selectable number of steps (from 1 to 99) upwards from the Dial frequency. Step size is determined as described in §4.9. Scanning stops and the PMS function is exited when a signal opens the squelch, or manually, and the displayed frequency becomes the new Dial frequency.

Before activating PMS, press **F+PSET** to display the number of steps to scan, and enter one two digits to change the setting, if desired, before pressing **F+PSET** again to return to normal display. Also, set the Dial frequency (§4.5) to the place you want the scan to start (bottom edge of range), and preset the squelch (§4.2).

To activate PMS, press **F+PMS**. The scanner will step up the pre-selected number of steps and then step back down to the starting point repeatedly until a signal opens the squelch, or until you press **D** or the PTT switch. The stopping frequency is now the Dial frequency.

EXAMPLE: to scan from 435.0 to 436.0 (445.0 to 446.0 in vers. A):

- (1) Press **F+PSET**, **4**, **0** and **F+PSET** to set 40 steps (25 kHz times 40 steps equals 1 MHz).
- (2) If the display shows a 2-meter band frequency, press **V/U** to change to UHF.
- (3) Press **F+STEP**, twice if necessary, so the display shows 25 (kHz per step). Then press **D** to return to Dial mode.
- (4) Press **5** and **D** to select 435.000 MHz (or 445.000 MHz in version A).
- (5) Press **F+PMS** to start the scan.

4.14 Split Transmit/Receive Memories

All memories including the Call channel memory can store standard repeater shifts from the Dial as mentioned in §4.8. However, Memories 1 through 4 can also be used to store independent transmit frequencies, such as for 'odd split' repeaters. This allows non-standard repeater frequencies to be stored in memory and then recalled without the need for the + or - RPT functions (§4.8).

First store the receiving frequency into one of memories 1 through 4 (§4.6). Then retune the Dial to the desired transmitting frequency, and press **F+TX M** followed by the same memory number again.

Note: You may wish to move some standard-shift data from memories 1 to 4 into other memories, to make room for the odd shift frequency data in these special memory channels. To copy standard-shift memory data, just recall the source memory, and then press **M** followed by the destination memory number. You can now enter new data over the source memory.

Recalling an odd-split memory is the same as for a regular memory, except that, if the + or - RPT function was active, it will be automatically switched off.

4.15 Tone Squelch Operation (version A with FTS-6 option)

When the optional FTS-6 Tone Squelch Unit is installed in version A transceivers, the subaudible tone frequency and encode/decode functions may be selected for operation and stored in memories.

Before setting the tone squelch frequency and functions, press **D** to enter the Dial mode.

To check and optionally set the tone frequency, press **F+ T SET**. The tone frequency will be displayed (in Hz), with a small 'c' if that tone selection is a high-Q type. To change the selected tone frequency, press the up or down arrow keys until the display shows the tone frequency you require (the display will step through the

standard EIA tones). Press **F+ T SET** again to return to the operating frequency display when the tone frequency is selected.

To toggle the tone squelch decoder on and off for reception (only signals sending the matching tone frequency will open the squelch), press **F+ DEC**. When the decoder is active, 'TONE' appears at the upper right corner of the display while receiving.

To toggle the tone squelch encoder on and off for transmission (so that your transmissions include the selected subaudible tone), press **F+ ENC**. When the encoder is active, 'TONE' appears at the upper right corner of the display while transmitting.

Once you have the tone squelch set up the way you want it, you can store it in memory (or the call channel) by pressing **M** and then the memory number (or *****). Afterwards, to change a setting stored in memory, just recall the memory, reset the tone frequency or function, and press **M** and the same memory number.

4.16 Crossband Semi Duplex Operation

With both 2-meter and 70-centimeter bands in the FT-727R, it is possible to transmit on one band and receive on the other. The frequencies used are those set in the Dial mode on each band.

First set the transmit band and frequency in the Dial mode as described in §4.4 and §4.5. Then press the **V/U** key to switch to the receive band, and select the receiving frequency.

To activate crossband operation, press **F+DUP**. 'DUP' will appear near the upper left corner of the display. You can now retune the receiving frequency using the up and down arrow keys, or if you want to reverse transmit and receive frequencies (and bands), just press the **V/U** key.

To deactivate crossband operation, press **D**.

4.17 Miscellaneous: Beep, Lock and Battery Voltage

As mentioned earlier, if the Keypad Lock function is activated, a small padlock icon will appear near the lower left corner of the display, and all keys will be disabled (preventing inadvertent data entry). Press **F+LOCK** to toggle the Lock function on and off.

The Beep function allows the keypad beeper to be toggled on and off. When on, a small bell icon appears near the upper left corner of the display, and pressing a key will cause a beep to sound when the key makes contact (during data entry while receiving). The beep that sounds during transmission (when a DTMF tone is sent via the keypad) is not affected by this function.

Battery voltage can be checked by the internal digital voltmeter at any time, without affecting operation. Press **F+BATT** while receiving to activate this function. A small 'V' will appear at the right side of the display, and the frequency display will be replaced with the supply voltage measurement. Resolution is 0.5V. Notice the voltage drop during transmission to get an idea of battery condition (see also §4.19).

To return to the operating frequency display, press **F+BATT** again.

4.18 In Case of Problems

The FT-727R offers so many features that it is not too difficult to get lost, at least until you have had the chance to learn the various functions of the keypad and display. If the display shows nothing at all, check the power switch (VOL control), and if necessary, remove the battery pack and check that the contacts are clean. If all appears to be physically in order, recharge or replace the batteries.

If the display shows no numbers, but only a decimal point in the center and a few labels, you are probably looking at a blank memory. Press **D** to return to the Dial mode.

Fortunately, the display itself includes enough symbols and function indicators to let you know what is going on, so it is well worthwhile to study the display diagram on page 9 carefully. For example, if the frequency display changes unexpectedly when you transmit (or if 'Err' appears), check for 'DUP', '-RPT' OR '+RPT' labels on the display. Also, if only two or three digits appear, check for a small 'v' at the right, indicating the battery voltmeter is activated (press **F+BATT** to turn it off), or the P SET or T SET functions are on (press **D** to abort).

If pressing a key appears to do nothing, first check for the padlock icon on the display. If it is not there, press **D**, which will terminate any partially entered commands and leave the set in the Dial mode. If you still cannot enter data, check the ON AIR indicator to see if it is red, indicating that the transceiver is transmitting. Releasing the PTT switch should return the set to receive. If still nothing happens, switch the transceiver off, and then back on. As a last resort, remove the battery pack and reset the microprocessor by setting the backup switch (§2.4) off for a few seconds, and then back on (toward the center of the radio) before replacing the battery pack. Then switch on the transceiver (the display will be blank), and press 443300 (U.S. version), or 433600 (European versions). Also, if yours is a European version (B1) requiring 7.6 MHz UHF repeater shift, immediately set this shift as described on pages 27 and 28 (§4.8). Otherwise, standard UHF repeater shift for European versions is 1.6 MHz.

To avoid confusion resulting from inadvertent key presses, set the keypad lock on (press **F+LOCK**) if you set the transceiver down while it is on, and then remember to set the lock back off when you wish to enter data.

4.19 Getting the Most From Your Batteries

How long the batteries will last before requiring recharge or replacement depends largely on your operating habits, and how you care for the battery pack (if using the FNB-3A or FNB-4A rechargeable Ni-Cds). The FT-727R offers a variety of ways to monitor and conserve battery consumption, and thus to extend the charge life of the batteries. Knowing how to use these features can be critical in emergencies.

Obviously the most effective way to save battery life is to always make sure that the set is switched off when not in use. This can also prevent serious damage that might result to the batteries if they are over-discharged.

Keeping the receiver squelched requires only about 30% of the power needed when receiving a signal or noise, so when listening for a call, choose a quiet frequency and set the squelch so that the receiver stays quiet on noise. Also, use the lowest possible volume setting when listening to signals. In noise environments, use an earphone or the YH-2 headset.

The Power Saver feature (§4.12) provides an additional 50 to 75% power savings over regular squelched monitoring, depending on the sleep time. This feature is only practical when listening on a truly quiet channel, however. It is easy to set up your own quiet channel when using the FTS-6 Tone Squelch option and a tone frequency used only by yourself and those from whom you expect to receive calls.

Keeping the LOW power switch on the top panel depressed requires about 60% less current when transmitting, so it is a good idea to develop the habit of always keeping this switch depressed, switching to high power only if low power fails to get through. If you live in a location where high power is almost always needed,

consider replacing the antenna with a higher gain type instead of opting for high power (the result is the same). However, with the FT-727R, you must be careful to ensure that any antenna used is designed for the selected operating band. For example, if you replace the YHA-27 with a full 5/8-wave whip for the 2-meter band, don't try to transmit on the 70-centimeter band without first putting the YHA-27 back on, or another antenna designed for UHF.

To determine the charge condition of your batteries, use the battery voltmeter function to monitor battery voltage during transmission. As the battery discharges, the voltage drop when transmitting will increase. As the battery voltage drops to around 6.5V, the red BATT LED indicator at the top of the front panel will start to light, indicating that the batteries should be replaced or recharged as soon as possible.

If using rechargeable batteries, do not keep operating once the BATT indicator has come on, as this could cause over-discharge of the cells and destroy the pack. However, recharging Ni-Cd batteries often, with little use in between charges, can also shorten the useful life of the cells. Therefore the best way to get the most out of your Ni-Cds is to use the battery pack just until the BATT indicator comes on, and then immediately give the pack a full recharge. Unfortunately this is not always convenient, since even with the battery voltmeter it can be hard to tell exactly when the charge will run out. One solution to this problem is to carry an extra, fully charged pack with you if you do not wish to have operation interrupted.

MEMO



E 2210100 E (8703—O S)